

## SELECTOR SWITCH TYPE 08

### MAIN FEATURES

HORIZONTAL, MULTI WAFER, PCB MOUNTING, UP TO 12 POSITIONS

- For PCB mounting
- 25'000 switching cycles with up to 9 Ncm switching torque
- Gold plated contacts: 3 micron
- Robust metal housing with metal shaft
- Operating temperature range: -40° to +85°
- Various options and customizations

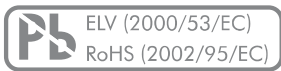

### PRODUCT VARIETY

- From 1 x 12 to 4 x 3 poles/positions per wafer
- Up to 8 wafers
- Shorting or non-shorting
- Switching torque 3, 6 or 9 Ncm
- Configurable End-Stops

### TYPE 08

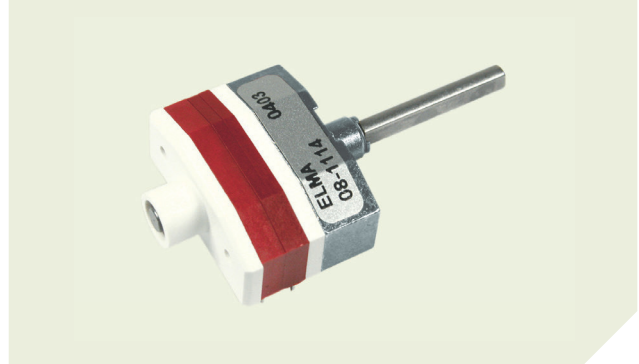

### POSSIBLE CUSTOMIZATIONS

- Shaft dimension and shape
- Switching torque
- Hollow shaft, inner shaft (see page 106)
- Others

### TYPICAL APPLICATIONS

- Industrial controls
- Avionics, instrumentation, test systems
- Medical and audio equipment

**1 PREFERENCE TYPES SELECTION CHART**

<sup>1</sup> For other types/options, see type key.

CONTACT ARRANGEMENT		NUMBER OF WAFERS	FUNCTION (POLES X POSITIONS)	STANDARD TYPE KEY	
COMMON WAFER PART CONTACT	SWITCHING WAFER PART CONTACT			SHORTING	NON-SHORTING
		1	1 x 12, endless rotating	08-1103	08-1104
		2	2 x 12, endless rotating	08-2103	08-2104
		3	3 x 12, endless rotating	08-3103	08-3104
		4	4 x 12, endless rotating	08-4103	08-4104
		1	1 x 12	08-1113	08-1114
		2	2 x 12	08-2113	08-2114
		3	3 x 12	08-3113	08-3114
		4	4 x 12	08-4113	08-4114
		1	2 x 6	08-1263	08-1264
		2	4 x 6	08-2263	08-2264
		3	6 x 6	08-3263	08-3264
		4	8 x 6	08-4263	08-4264
		1	3 x 4	08-1343	08-1344
		2	6 x 4	08-2343	08-2344
		3	9 x 4	08-3343	08-3344
		4	12 x 4	08-4343	08-4344
		1	4 x 3	08-1433	08-1434
		2	8 x 3	08-2433	08-2434
		3	12 x 3	08-3433	08-3434
		4	16 x 3	08-4433	08-4434

\* Common interconnection to be made on PCB.

**STOP AND FIXING SCREWS**

Configurable stop screws can be set at any position between 2 and the maximum. Stop screws have to be ordered separately.

	PACKAGING SIZE	ORDER NUMBER
Stop screw M1.2	10 pcs.	4224-11
Stop screw M1.2	100 pcs.	4224-10
Fixing screw M2 x 6	10 pcs.	4224-01

**AVAILABLE IN KIT FORM**

Mechanism, wafer and shaft are supplied separately. This offers more possibilities to place the switch onto the PC-board.

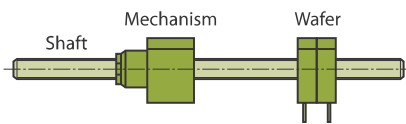

View of wafer from front side

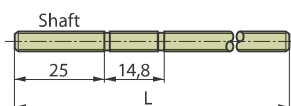
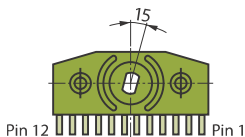

**WAFER**

FUNCTIONS (POLES X POSITIONS)	SHORTING	NON-SHORTING
1 x 12	4217-10	4218-10
2 x 6	4217-11	4218-11
3 x 4	4217-13	4218-13
4 x 3	4217-12	4218-12

**SWITCH MECHANISM**

NUMBER OF POLES	POSITIONS	TORQUE	ORDER NUMBER
≤ 6	12	6 Ncm	4214-10
> 6	12	9 Ncm	4214-12

**SHAFT INCLUDING ASSEMBLY MATERIAL**

LENGTH L	NO. OF HOUSINGS	ORDER NUMBER
75 mm	3	4211-05
100 mm	5	4211-10
125 mm	7	4211-15
150 mm	9	4211-20

## SPECIFICATIONS

### MECHANICAL DATA

Resolution:	12 positions max. (30° indexing)
Switching torque (new condition):	3, 6 or 9 Ncm (+/- 25%), additional wafers may increase switching torque
Rotational life:	25'000 switching cycles min.
Fastening torque of nut:	200 Ncm max.

### ELECTRICAL DATA

Function:	From 1 x 12 to 4 x 3 poles/positions per wafer
Switching mode:	Shorting or non-shorting
Load current:	1.5 A max. (resistive load)
Switching voltage:	42 VDC max.
Contact resistance (new condition):	20 mΩ max.
Insulation resistance (new condition):	10 <sup>13</sup> Ω min. (contact to contact / housing)
Switching capacity:	1 pF max. (contact to contact)
Dielectric withstanding voltage:	500 VDC during 60 seconds

### MATERIAL DATA

Shaft:	Stainless steel
Bushing/housing:	Zinc diecast, zinc plated and passivated
Contact plating:	Gold; 3 μm
Insulation material:	Wafer: PA6/6T, rotor: Polyacetal (POM)
Soldering leads:	Alloy copper, tin plated

### ENVIRONMENTAL DATA

Operating/storage temperature range:	-40° to +85°C
IP sealing:	IP60 shaft/front panel sealing
Vibration:	10 G <sub>rms</sub> max. @ 10 to 2000 Hz
Flammability:	UL94-HB

### PACKAGING QUANTITY

Tray:	10 pcs.
-------	---------

### SOLDERING CONDITIONS

Hand soldering:	340°C max. during 2 sec max.
Wave soldering:	280°C max. peak temperature during 5 sec max.

## SWITCHING MODES

For information about switching modes please see **technical explanations** at the end of the catalog

**DRAWINGS**

Tolerances unless otherwise specified DIN ISO 2768-1 (m)

SWITCH WITH 2 WAFERS

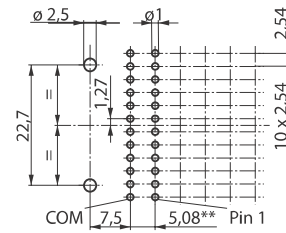
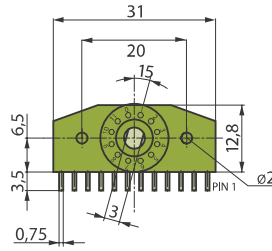
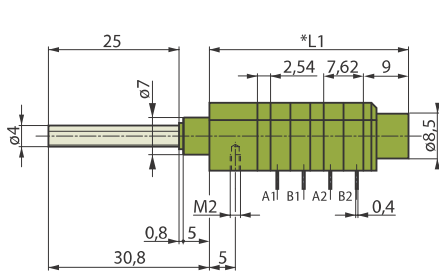

Ax = Common contact wafer of x  
Bx = Switching contact wafer of x

- \* L - 1 wafer 28.2 mm  $\pm$  1 mm
- 2 wafers 38.36 mm  $\pm$  1 mm
- 3 wafers 48.52 mm  $\pm$  1 mm
- 4 wafers 58.68 mm  $\pm$  1 mm
- per additional wafer + 10.16 mm
- \*\* All further steps are in 5.08 mm pitch

**SWITCH WITH BCD CODING**

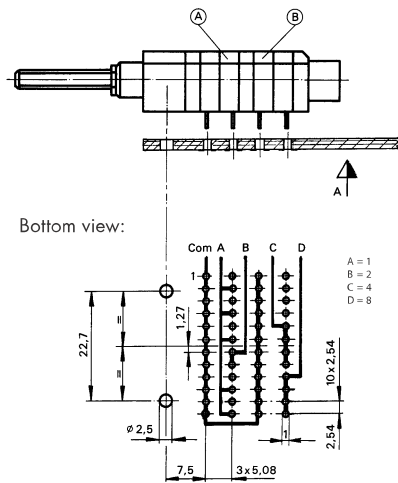

**BCD CODING**

For 12 positions, the coding will be made according to the layout on the left (on the printed circuit). If the switch is composed of component parts, the housings A (3 x 4) and B (1 x 12) have to be ordered. Limiting to 10 positions (BCD) is done with a stop screw M1.2 x 2.5.

**BCD Coding**

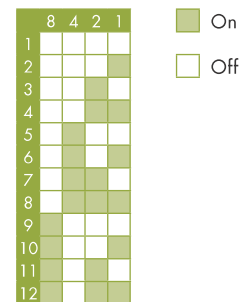

**HOLLOW SHAFT SYSTEM (CUSTOMIZED SOLUTION)**

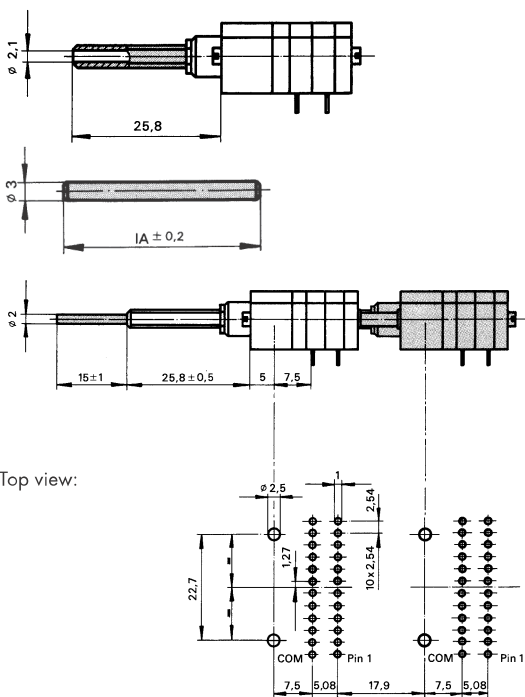

**HOLLOW SHAFT**

Available for switches up to 4 wafers; inner shaft ( $\varnothing 2$  mm) to be ordered separately.

**INNER SHAFT**

Must be ordered separately for switches with hollow shaft.

**SWITCH WITH CONCENTRIC SHAFTS**

Consisting of a hollow outer and inner shaft, the inner shaft driving a maximum of 3 wafers with 4 wipers each. Please indicate type of each switch.

**TYPE KEY**



**STANDARD TYPE KEY**  
(see page 104)

**NUMBER OF WAFERS**  
(max. 8)  
> 8 on request

**NUMBER OF POLES**  
Number of poles per wafer

**FACTORY SET CHARACTER**  
Defined by Elma  
(see page 104, is composed of switching mode, poles and positions)

**SWITCHING MODE**  
**3** Shorting  
**4** Non-shorting

**TORQUE**  
- 6 Ncm  
**M** 3 Ncm  
**N** 9 Ncm

**FACTORY SET END-STOP**

- 00** 12 pos. (standard)
- 11** 11 pos.
- 10** 10 pos.
- 09** 09 pos.
- 08** 08 pos.
- 07** 07 pos.
- 06** 06 pos.
- 05** 05 pos.
- 04** 04 pos.
- 03** 03 pos.
- 02** 02 pos.

**SHAFT LENGTH (AL)**

- 000** 30.8 mm
- <sup>1</sup>xxx** Custom  
(e.g. 18.5 mm = 185)

<sup>1</sup> Customized shaft length  
Shaft length (AL) description measured from mounting face (see picture below).

Max. shaft length (AL): 30.8mm

## GENERAL SWITCH KNOWLEDGE

### POSITION

A position is the mechanical detent of a switch actuator.

### DETENT

A detent is a mechanical positioning device for stopping actuator travel at each successive electrical circuit; for example, a spring-operated ball and groove.

### POLE

A pole is a single common electrical input having one or more outputs.

### WAFFER, DECK OR LAYER

A wafer/deck or layer is a section what the contacts are mounted on.

### INDEXING ANGLE

An indexing angle is the number of degrees between each position.  
For example: 12 positions for a total of 360 degrees result a 30 degrees indexing angle.

### NON-SHORTING CONTACTS "BREAK BEFORE MAKE"

A non-shorting contact is also known as "break before make" and describes the action of one circuit of a pole before interrupting another of the same pole. The switch will be momentarily interrupted before it changes from position 1 to position 2 during actuation (see picture).

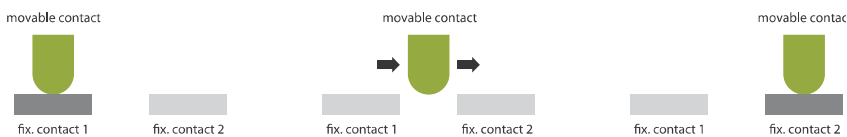

### SHORTING CONTACTS "MAKE BEFORE BREAK"

A shorting contact is also known as "make before break" and describes the action of one circuit of a pole before interrupting another of the same pole. The switch will momentarily "short" position 1 and 2 during actuation (see picture).

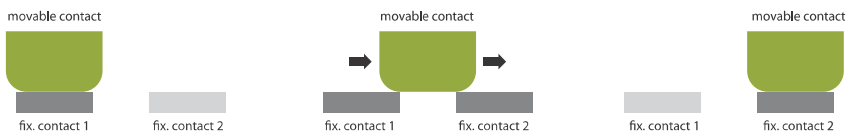

### CYCLE

A cycle is the complete sequence of indexing through all successive switch positions and returning to the original position. The rotational life from coded or selector switches are usually specified with cycles.

### REVOLUTION

A revolution is the complete sequence of indexing through all successive switch positions in the same direction. The rotational life from encoded switches are usually specified with revolutions.

### BENEFITS OF GOLD-PLATED CONTACTS

Gold-plated contacts should be used for longer rotational life, in corrosive environment or in case the switch will not be actuated for a long period of time.